



JGHV-531 HIGH VOLUME LOW PRESSURE SPRAY GUN

IMPORTANT: Before using this equipment, read all safety precautions and instructions. Retain for future use.

DESCRIPTION

The JGHV-531 is a high production, high volume, low pressure spray gun. It can be used with a wide variety of finishing materials. All models are designed to provide maximum transfer efficiency by **limiting air cap pressure to 10 psi (complies with rules issued by SCAQMD and other air quality authorities)**. The gun is intended for use with pressure feed paint supply only.

Most finishing materials can be atomized with the 33A air cap. The 33A air cap should be used where possible as it consumes less air volume (CFM) and has slightly better transfer efficiency than the 46MP or 83MP air caps. However, more difficult to atomize materials (i.e. low VOC's) or high flow applications (over 12 ounces/minute), are ideal for the 46MP (maximum performer) air cap, fluid tip and baffle combination. Also available is the 83MP (maximum performer) for even higher flows (17 oz./min. and above), and viscosities. Refer to the air cap chart for more information. Spray guns with a 33A nozzle combination can be converted to 46MP or 83MP if desired.

AIR CAPS - PATTERNS - APPLICATIONS

Air Cap #	*Typical Pattern Size and Shape	Typical Application
33A	9" long, tapered ends, similar to #30 air cap.	Most common finishing materials up to 12 oz./min.
46MP	11" long, straight-sided similar to #704 air cap	Low VOC material 12 to 16 oz./min.
83MP	13" long, straight-sided, similar to #765 air cap.	Low VOC material 17 oz./min & above.

*Actual pattern length dependent upon fluid tip ID, fluid flow rate, viscosity, air pressure, and fan pressure.

Standard Combinations Available:

Order No.	Gun Inlet Pressure
JGHV-531-33FF, FX	50 PSI
▲ JGHV-531-46FF, FX	50 PSI
JGHV-531-83D, E	65 PSI
JGHV-531-3-46FF*	50 PSI
JGHV-531-3-46FX*	50 PSI

* Models include 300 S.S. fluid tip (U.H.M.W. Poly. Seat) and Needle

▲ Government NSN No. 4940-01-315-8352 = JGHV-531-46FF

These gun models will produce approximately 10 psi cap pressure at the corresponding gun inlet pressure, as measured at the gun inlet. Air cap test kits (see Accessories) should be used to insure 10 psi air cap pressure is not exceeded.

Note

This gun may be used with chlorinated solvents; but, see page 2 for additional warnings.

INSTALLATION

Do not use more pressure than is necessary to atomize the material being applied. To provide optimum performance and assure compliance with all air quality regulations, an air cap test gauge kit is available to determine actual air cap pressures being used. See Accessories.

Connect the gun to a clean, moisture and oil free air supply using a hose size of at least **5/16" I.D. Avoid use of quick detachable connectors.** Do not use 1/4" ID hose (25' x 1/4" hose at 18 CFM has a pressure loss of 25 psi. A 25' x 5/16" hose at 18 CFM has a pressure loss of 8.1 psi).

Note

Depending on hose length, larger hose I.D. may be required. Install an HAV-501 air gauge at the gun handle and air cap test kit over tip. When gun is triggered on, adjust regulated pressure to desired setting to provide a maximum of 10 psi at the air cap.

OPERATION

Adjust fluid pressure to deliver the desired paint volume. Refer to the next paragraph also on "Back Pressure". Adjust air pressure and flow to provide a uniform dispersion of atomized paint throughout the pattern. Excessive flow rates will result in

heavy center spray patterns. Inadequate flows may cause the pattern to split. See Spray Gun Guide, SB-2-001 latest revision, for details concerning set up of spray guns or Troubleshooting section on Page 5.

Back Pressure - 46MP & 83MP "Maximum Performer"

Due to the unique cone shape of the MP fluid tips, a slight back pressure is created against the fluid column. This will reduce the amount of fluid output. To compensate, increase the fluid regulator pressure slightly. With 10 PSI cap pressure, back pressures are approximately 3.5 PSI with the 46MP and 2.0 PSI with the 83MP. This will not cause more fluid usage.

HVLP requires gun distances of 6-8" be used. Excess distance will produce inferior results.

PREVENTIVE MAINTENANCE

Note

If the baffle (6) is removed for any reason, replace the o-ring (5). To prevent damage to the o-ring during installation, apply SSL-10 gun lube to exterior of o-ring and ID of baffle.

To clean air cap and fluid tip, brush exterior with a stiff bristle brush. If necessary to clean cap **never**, use a broom straw or toothpick. **Never use a wire or hard instrument.** This may scratch or burr holes causing a distorted spray pattern.

To clean fluid passages, remove excess material at source, then flush with a suitable solvent using a device such as the SolventSaver™ (see Accessories). Wipe gun exterior with a solvent-dampened cloth. Never completely immerse in solvent as this is detrimental to lubricants and packings.

FLUID INLET GASKET (7) REPLACEMENT INSTRUCTIONS

1. Remove fluid inlet adapter with appropriate wrench.
2. Clean Loctite from gun body inlet threads and seal area.
3. Place gasket (7) squarely onto fluid inlet adapter and push down until flat against the shoulder.
4. Place a couple of drops of thread sealant (medium strength blue No. 242 Loctite or equal) on threads before installing fluid inlet adapter.
5. Torque fluid inlet adapter to 20-25 ft. lbs. and tighten locknut.

SAFETY PRECAUTIONS

This manual contains information that is important for you to know and understand. This information relates to USER SAFETY and PREVENTING EQUIPMENT PROBLEMS. To help you recognize this information, we use the following symbols. Please pay particular attention to these sections.



Important safety information - A hazard that may cause an injury or loss of life.







Important information that tells how to prevent damage to equipment.

Note

Information that you should pay special attention to.



The following hazards may occur during the normal use of this equipment. Please read the following chart before using this equipment.

HAZARD	CAUSE	SAFEGUARDS
Fire 	Solvent and coatings can be highly flammable or combustible especially when sprayed.	Adequate exhaust must be provided to keep air free of accumulations of flammable vapors. Smoking must never be allowed in the spray area. Fire extinguishing equipment must be present in the spray area.
Solvent Spray 	During use and while cleaning and flushing, solvents can be forcefully expelled from fluid and air passages. Some solvents can cause eye injury.	Wear eye protection.
Inhaling Toxic Substances 	Certain materials may be harmful if inhaled, or if there is contact with the skin.	Follow the requirements of the Material Safety Data Sheet supplied by your coating material manufacturer. Adequate exhaust must be provided to keep the air free of toxic materials. Use a mask or respirator whenever there is a chance of inhaling sprayed materials. The mask must be compatible with the material being sprayed and its concentration. Equipment must be as prescribed by an industrial hygienist and be NIOSH approved.
Explosion Hazard - Incompatible Materials 	Halogenated hydrocarbon solvents - for example; methylene chloride and 1, 1, 1 - Trichloroethane are not chemically compatible with the aluminum that might be used in many system components. The chemical reaction caused by these solvents reacting with aluminum can become violent and lead to an equipment explosion.	Guns with stainless steel internal passageways may be used with these solvents. However, aluminum is widely used in other spray application equipment - such as material pumps, regulators, valves and cups. Check all equipment items before use and make sure they can also be used safely with these solvents. Read the label or data sheet for the material you intend to spray. If in doubt as to whether or not a coating or cleaning material is compatible, contact your material supplier.
General Safety	Improper operation or maintenance of equipment.	Operators should be given adequate training in the safe use & maintenance of the equipment (in accordance with the requirements of NFPA-33, Chapter 15). Users must comply with all local and national codes of practice & insurance company requirements governing ventilation, fire precautions, operation, maintenance and housekeeping. These are OSHA Sections 1910.94 and 1910.107 and NFPA-33.
Cumulative Trauma Disorders (CTD's) CTD's, or musculo-skeletal disorders, involve damage to the hands, wrists elbows, shoulders, neck and back. Carpal tunnel syndrome and tendinitis (such as tennis elbow or rotor cuff syndrome) are examples of CTD's.	Use of hand tools may cause cumulative trauma disorders ("CTD's"). CTD's, when using hand tools, tend to affect the upper extremities. Factors which may increase the risk of developing a CTD include: 1. High frequency of the activity. 2. Excessive force, such as gripping, pinching, or pressing with the hands and fingers. 3. Extreme or awkward finger, wrist, or arm positions. 4. Excessive duration of the activity. 5. Tool vibration. 6. Repeated pressure on a body part. 7. Working in cold temperatures. CTD's can also be caused by such activities as sewing, golf, tennis and bowling, to name a few.	Pain, tingling, or numbness in the shoulder, forearm, wrist, hands or fingers, especially during the night, may be early symptoms of a CTD. Do not ignore them. Should you experience any such symptoms, see a physician immediately. Other early symptoms may include vague discomfort in the hand, involve loss of manual dexterity, and nonspecific pain in the arm. Ignoring early symptoms & continued repetitive use of the arm, wrist and hand can lead to serious disability. Risk is reduced by avoiding or lessening factors 1-7.

CAUTION

To prevent damage to the fluid tip (3) or fluid needle (29), be sure to either 1) pull the trigger and hold while loosening or tightening the fluid tip or 2) remove fluid needle adjusting screw (33) to relieve spring pressure.

If the air cap is changed, the baffle must also be changed. Use of incorrect baffle and cap set will result in substandard performance and or improper air cap pressures. See Chart 2 for ordering information.

Maximum air pressure required to assure compliance of 10 PSI Max. Cap Pressure - this reading must be taken at the spray gun handle inlet fitting.

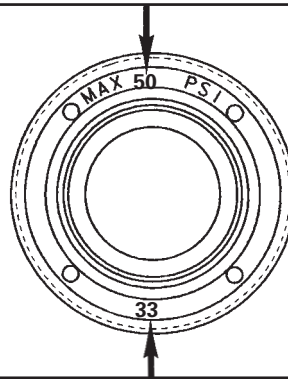

Air cap number located on face of cap - cap number must correspond with baffle number to assure 10 PSI cap pressure.

SPRAY GUN LUBRICATION

Daily, apply a drop of tSSL-10 gun lube at trigger bearing stud (21) and the stem of the air valve (14) where it enters the air valve assembly (17). The shank of the fluid needle (29) where it enters the packing nut (19) should also be oiled. Make sure baffle and retaining ring threads are clean and free of foreign matter. Before assembling air cap to baffle, clean the retaining ring and baffle threads thoroughly, then add two drops of SSL-10 spray gun lube to threads.

The fluid needle spring (31) and air valve spring (15) should be coated with a very light grease, ensuring that any excess grease will not clog the air passages. For best results, lubricate the points indicated daily using SSL-10 spray gun lube.

- A. Trigger points
- B. Packing
- C. Adjusting valve
- D. Baffle & retaining ring threads
- E. Air valve cartridge

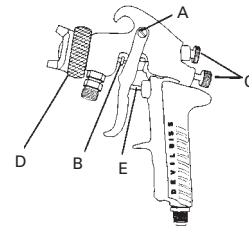

† A "Material Safety Data Sheet" for SSL-10 gun lube is available from DeVilbiss upon request.

CHART 1

STANDARD FLUID TIPS & NEEDLES - MATCHED SETS (400 GR. S.S. TIP/303 S.S. NEEDLE)			
If this is No. on Tip, Order →	Fluid Tip I.D. Inches (mm)		Matched Fluid Tip & Needle Assembly
AV-2115-FX	.042	(1.1)	JGA-4040-FX
AV-2115-FF	.055	(1.4)	JGA-4040-FF
AV-2120-FX*	.042	(1.1)	JGA-4045-FX*
AV-2120-FF*	.055	(1.4)	JGA-4045-FF*
AV-2120-E**	.070	(1.8)	JGA-4045-E**
AV-2120-D**	.086	(2.2)	JGA-4045-D**
OPTIONAL FLUID TIPS AND NEEDLES - MATCHED SETS (303 GR. S.S. AND U.H.M.W. POLY)			
AV-4915-FX	.042	(1.1)	JGA-4056-FX
AV-4915-FF	.055	(1.4)	JGA-4056-FF
AV-4920-FX*	.042	(1.1)	JGA-4051-FX*
AV-4920-FF*	.055	(1.4)	JGA-4051-FF*
AV-4920-E**	.070	(1.8)	JGA-4051-E**
AV-4920-D**	.086	(2.2)	JGA-4051-D**

*For use with 46MP air cap.

**For use with 83MP air cap.

Note: Do not use AV-1 gasket with this spray gun.

PARTS LIST

Ref. No.	Replacement Part No.	Description	Individual Parts Req.
1	MBC-368	Retaining Ring	1
2	See Chart 2	Air Cap	1
3	See Chart 1	Fluid Tip	1
•4	JGD-14-K10	Seal (Kit of 10)	1
		(Polyethylene)	
•5	SSG-8182-K5	O-Ring (Kit of 5) (Buna-N)	1
6	See Chart 2	Baffle, Seal and O-Ring Kit	1
7	MSV-3-K10	Gasket Kit (Kit of 10)	
8	---	Locknut	1
9	---	Fluid Inlet Adapter 3/8 NPS	1
10	JGA-4044	Fluid Inlet and Nut Kit	1
•11	JGA-14-K25	Snap Ring (Kit of 25)	1
•12	JGA-15-K25	Washer (Kit of 25)	1
•13	JGS-26-K25	"U" Cup (Kit of 25)	1
•14	JGS-431-K25	Air Valve (Kit of 25)	1
•15	MBD-12-K25	Spring (Kit of 25)	1
•16	JGS-72-K10	Gasket (Kit of 10) (Teflon)	2
#17	JGS-449-1	Air Valve Assembly	1
•18	JGV-463-K3	Fld. Needle Packing (Kit of 3) ...	1
19	34411-122-K10	Needle Packing Nut	1
		(Kit of 10)	
•20	---	Screw	1

Ref. No.	Replacement Part No.	Description	Individual Parts Req.
21	---	Trigger Bearing Stud	1
22	JGS-478	Stud & Screw Kit (Kit	1
		includes 3 studs, 5 screws)	
23	JGS-477-1	Trigger, Stud and Screw Kit	1
		(Kit includes 1 each)	
24	JGA-132	Plug	1
25	P-MB-51	Connector 1/4" NPS	1
26	JGA-497-1	Air Valve Assembly - Horn	1
•27	---	Retaining Ring	1
•28	SSG-8069-K25	O-Ring Kit (Kit of 25)	1
29	See Chart 1	Fluid Needle	1
30	---	Gun Body Bushing	1
•31	MBD-19-K10	Spring (Kit of 10)	1
•32	---	Spring Pad (Included in #31) ...	1
33	JGS-16	Needle Adjusting Screw	1
34	JGA-4041	Bushing, Spring & Knob Kit	1
35	See Chart 1	Lapped Fluid Tip and Needle ...	1
		(Not shown) (includes Ref. Nos. 3 and 29)	



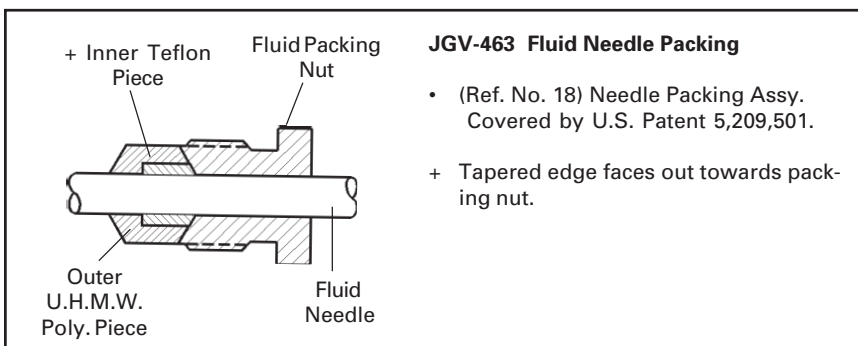
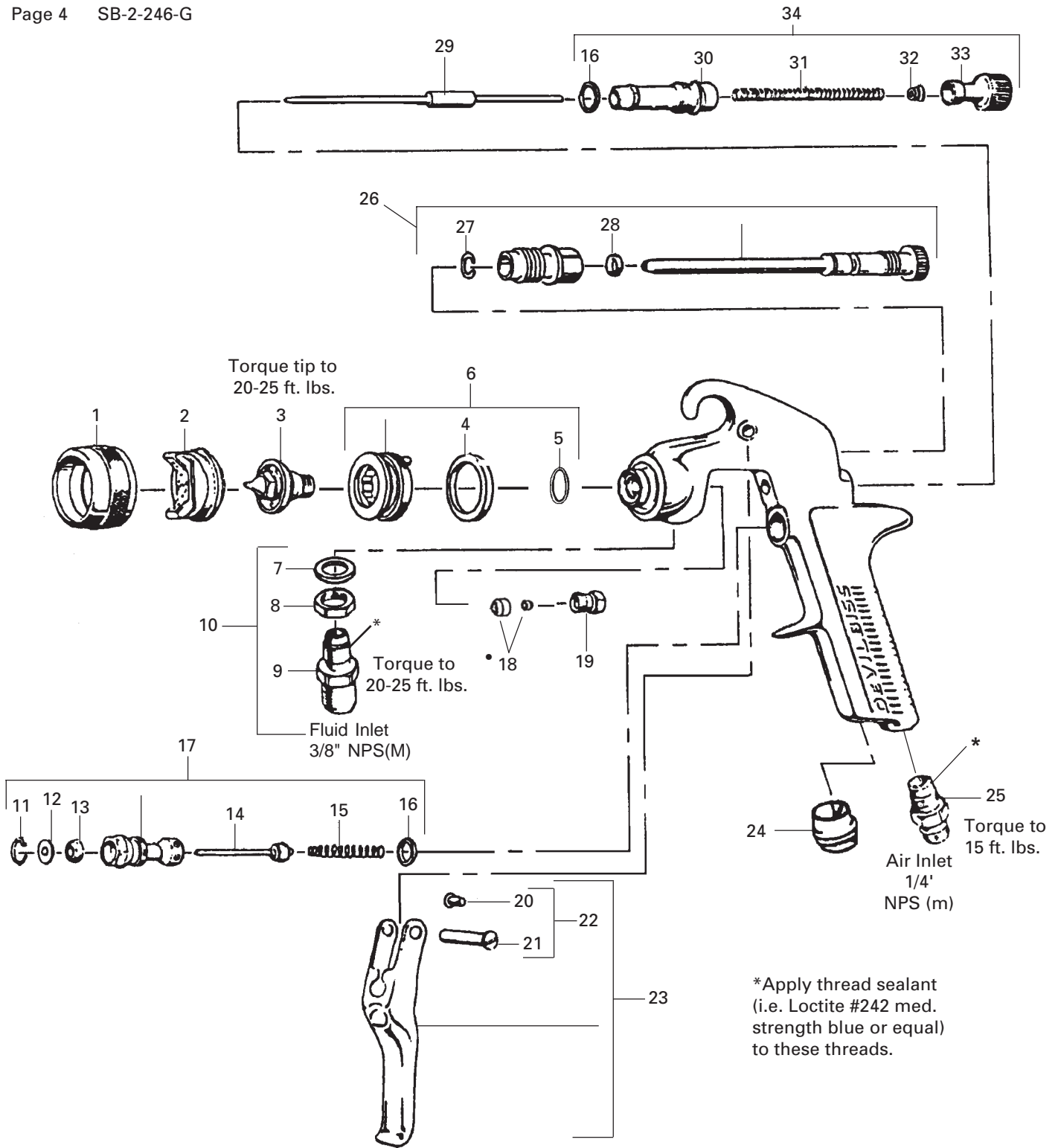

• A quantity of necessary parts is included in Gun Repair Kit ■ KK-4987-2 and should be kept on hand for service convenience.

■ Government NSN No. 4940-01-046-9919 = KK-4987-2.



AIR CAP & BAFFLE COMBINATIONS								
No.Stamped on Parts		Set		CFM @ Cap Pressure				
Air Cap Part No.	Baffle	Ref. No. 2 Air Cap	Ref. No. 6 Baffle	2 PSI	4 PSI	6 PSI	8 PSI	10 PSI
33A	33-50	JGHV-101-33A	JGHV-450-33-50	8.25	11.75	14.5	16.75	18.75
46MP	46-50	JGHV-101-46MP	JGHV-450-46-50	8.5	13.0	16.5	19.75	22.5
83MP	83-65	JGHV-101-83MP	JGHV-450-83-65	10.0	15.5	19.5	23.0	26.0

TROUBLESHOOTING











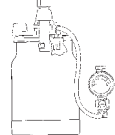
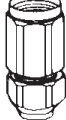
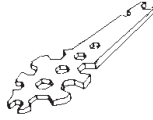

CONDITION	CAUSE	CORRECTION
Heavy top or bottom pattern 	Horn holes plugged. Obstruction on top or bottom of fluid tip. Cap and/or tip seat dirty.	Clean. Ream with non-metallic point. Clean. Clean.
Heavy right or left side pattern 	Left or right side horn holes plugged. Dirt on left or right side of fluid tip. Remedies for top-heavy, bottom-heavy, right-heavy and left-heavy patterns: 1) Determine if obstruction is on cap or fluid tip. Do this by making a test pattern. Then, rotate cap one-half turn and spray another pattern. If defect is inverted, obstruction is on air cap. Clean air cap as previously instructed. 2) If defect is not inverted, it is on fluid tip. Check for a fine burr on edge of fluid tip. Remove with #600 wet or dry sand paper. 3) Check for dried material just inside opening. Remove by cleaning.	Clean. Ream with non-metallic point. Clean.
Heavy center pattern 	Material flow exceeds air cap's capacity. Atomizing pressure too low. Material too thick.	Thin or lower fluid flow. Increase pressure. Thin to proper consistency.
Split spray pattern 	Fluid adjusting knob turned in too far. Atomization air pressure too high.	Back out counterclockwise to achieve proper flow. Reduce air pressure.
Jerky or fluttering spray 	*Loose or damaged fluid tip /seat. Material level too low. Container tipped too far. Obstruction in fluid passage. Loose or broken fluid tube or fluid inlet nipple. Dry or loose fluid needle packing nut.	Tighten or replace. Refill. Hold more upright. Clean according to material supplier's recommendations. Tighten or replace. Lubricate or tighten.
Will not spray	No air pressure at gun. Fluid needle adj. screw not open enough. Fluid pressure too low with internal mix cap and pressure tank.	Check air supply and air lines. Open fluid needle adjusting screw. Increase fluid pressure at tank.
Excessive overspray	Too much atomization air pressure. Gun too far from work surface. Improper stroking (arching, gun motion).	Reduce pressure. Adjust to proper distance. Too fast. Move at moderate pace, parallel to work surface.
Dry Spray	Air pressure too high. Gun tip too far from work surface. Gun motion too fast. Gun out of adjustment.	Decrease air pressure. Adjust to proper distance. Slow down. Adjust.
Fluid leaking from packing nut	Packing nut loose. Packing worn or dry.	Tighten, do not bind needle. Replace or lubricate.
Fluid leaking or dripping from front of gun	*Foreign matter in tip. Packing nut too tight. Dry packing. Fluid tip or needle worn or damaged. Fluid needle spring deformed or broken.	Clean. Adjust. Lubricate. Replace tip & needle with lapped sets. Replace.
Runs and sags	Too much material flow. Material too thin. Gun tilted on an angle.	Adjust gun or reduce fluid pressure. Mix properly or apply light coats. Hold gun at right angle to work and adapt to proper gun technique.
Thin, sandy coarse finish. Drying before it flows out.	Gun too far from surface. Too much air pressure. Improper thinner being used.	Check distance. Normally 6-8". Reduce air pressure and check spray pattern. Follow paint manufacturer's mixing instructions.

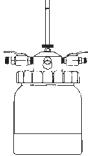
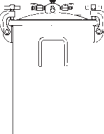
* Most common problem.

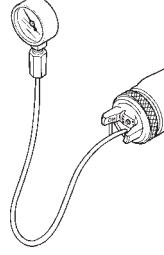
TROUBLESHOOTING (Continued)

CONDITION	CAUSE	CORRECTION
Thick, dimpled finish (orange peel). Too much material coarsely atomized.	Gun too close to surface. Air pressure too low. Improper thinner being used. Material not properly mixed. Surface rough, oily, dirty.	Check distance. Normally 6-8". Increase air pressure or reduce fluid pressure. Follow paint manufacturer's mixing instructions. Follow paint manufacturer's mixing instructions. Properly clean and prepare.
Excessive fog	Too much, or too fast-drying thinner. Too much atomization air pressure.	Remix properly. Reduce pressure.
Unable to get round spray	Fan adjustment screw not seating properly. Air cap retaining ring loose.	Clean or replace. Tighten.

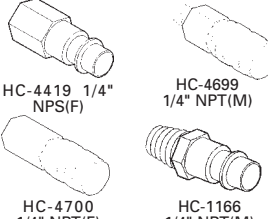
ACCESSORIES

<p>KB-555 (Aluminum) & KB-545-SS (S/S) 2 Qt Pressure Feed Cup with Regulator</p>  <p>Provides greater degree of control.</p>	<p>Millennium 3000 Twin Cartridge Paint Spray Respirator</p>  <p>NIOSH-Certified, for respiratory protection in atmospheres not immediately dangerous to life.</p>	<p>TLC-576 Aluminum Cup (Teflon Lined) & TSC-591 Stainless Steel Cup</p>  <p>1 Qt. pressure feed cups. 3/8" NPS (F), cam locked lid. Requires KK-4980 Regulator Kit.</p>	<p>VS-531 Low Pressure Strainers</p>  <p>The VS-531 Low Pressure Fluid Strainer provides a final filter for trapping foreign particles in the paint supply.</p>	<p>WR-103 Wrench</p>  <p>Contains all necessary tip, hose and nut sizes used on or with gun.</p>	<p>42884-214-K5 (3/8") & 42884-215-K10 (5/8") Cleaning Brushes</p>  <p>These brushes are helpful in cleaning threads and recesses of gun body.</p>	
<p>SPRAY GUN LUBE SSL-10 (2 oz. bottle)</p>  <p>Compatible with all paint materials; contains no silicone or petroleum distillates to contaminate paint. MSDS available upon request.</p>	<p>HD-503 SolventSaver™ Hose/Gun Cleaner</p>  <p>2 Qt. Hose/Gun Cleaner used to clean the inside of hose and material passages of gun.</p>	<p>OMGZ SolventSaver™ 2 Gallon Galvanized Tank Hose/Gun Cleaners</p>  <p>Used to clean the inside of hose and material passages of the gun.</p>	<p>JGA-52-K10 Packings</p>  <p>Usually used when abrasive materials are sprayed. Use (2) JGA-52 packings in place of JGV-463 packing.</p>	<p>Air Cap Test Kit KK-5033-33A for JGHV-101-33A KK-5033-46MP for JGHV-101-46MP KK-5033-83MP for JGHV-101-83MP</p>  <p>The purpose of this test kit is to measure air cap atomizing air pressure at the center air port of the air cap. Used to confirm code compliance and as a daily quality control measure.</p>		
<p>MSA-4-K10 Fluid Needle Spring (replaces MBD-19)</p>  <p>Provides reduced spring force (4 lbs. verses 6 lbs.) for easier trigger pull.</p>	<p>JGA-4035-K5 Optional 3 Piece Packings</p>  <p>This 3 piece packing can be used in place of Ref. (8) JGV-463, 2 piece packing.</p>	<p>MSV-457-46 Baffle Assembly</p>  <p>Eliminates need of using SSG-8182-K5 "O" ring (Ref. No. 5).</p>	<p>Quick Disconnect Approved for HVLP Guns (Air) High Flow Ball and Ring Type</p>  <p>HC-4419 1/4" NPS(F) HC-4699 1/4" NPT(M) HC-4700 1/4" NPT(F) HC-1166 1/4" NPT(M)</p>		<p>29-3100 Scrubs® Hand Cleaner Towels</p>  <p>Scrubs® are a pre-moistened hand cleaner towel for painters. No water is needed.</p>	<p>JGA-444 Fluid Tube</p> <p>This tube combines the fluid and air hoses at gun handle preventing dragging hoses over work, twisting lines and improving overall gun handling.</p>

WARRANTY

This product is covered by DeVilbiss' 1 Year Limited Warranty.

DeVilbiss Worldwide Sales and Service Listing: www.devilbiss.com

ITW Industrial Finishing

DeVilbiss has authorized distributors throughout the world. For technical assistance or the distributor nearest you, see listing below.

U.S./Canada Technical Service Office:

195 Internationale Blvd., Glendale Heights, IL 60139
 Toll-Free Telephone: 1-888-992-4657 (U.S.A. and Canada only)
 Toll-Free Fax: 1-800-368-8401

